

FPZ
BLOWER TECHNOLOGY

SERIES K-TD MOR

EU VERSION

TECHNICAL CHARACTERISTICS

- Aluminium alloy construction
- High efficiency impeller

OPTIONS

- Special Voltages (IEC 60038)
- Surface treatments
- Increased seal version

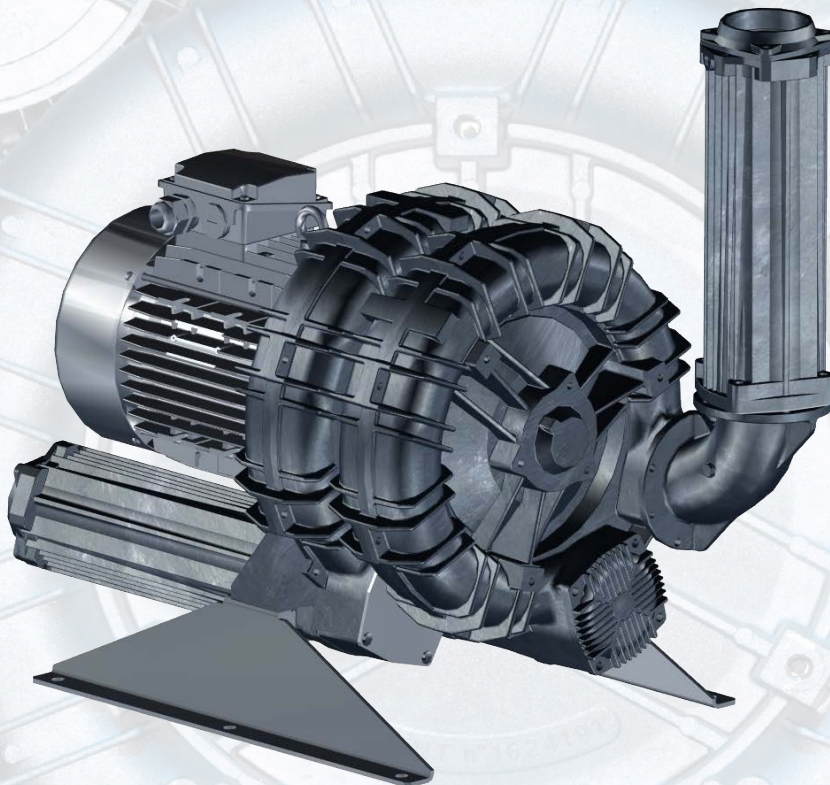

Data sheet

LATERAL CHANNEL BLOWER-EXHAUSTER

COMPANY WITH QUALITY MANAGEMENT
SYSTEM CERTIFIED BY DNV
= ISO 9001:2008 =



PRESSURE

Model	N 2900 rpm [kW]	N 3500 rpm [kW]	Q max 2900 rpm [m³/h]	Q max 3500 rpm [m³/h]	ΔP max 2900 rpm [hPa] (mbar)	ΔP max 3500 rpm [hPa] (mbar)	Leq ¹ 2900 rpm (Lp) [dB(A)]	Leq ¹ 3500 rpm (Lp) [dB(A)]	Weight ² max [kg]
K04-TD	1,1	1,3	139	168	175	140	68	70	25,5
	1,5	1,75	139	168	250	215	69	71	26,5
	2,2	2,55	139	168	400	350	70	72	29,5
K05-TD	2,2	2,55	215	259	240	210	71	73	36
	3	3,45	215	259	350	300	72,5	74,5	40
	4	4,6	215	259	475	425	74	76	43,5
K06-TD	4	4,6	312	376	275	225	73	75	49,2
	5,5	6,3	312	376	425	350	74	76	56,5
	7,5	8,7	312	376	550	525	75	77	61,5
K07-TD	5,5	6,3	416	502	325	275	78,9	80,9	85
	7,5	8,7	416	502	475	410	79,2	81,2	90
	9,2	10,6	416	502	575	525	79,5	81,5	99,5
	-	12,7	416	502	-	650	-	81,8	100,5
K08-TD	5,5	6,3	518	625	235	180	78,1	80,1	90,5
	7,5	8,7	518	625	350	290	78,4	80,4	95,5
	9,2	10,6	518	625	450	390	78,7	80,7	105
	11	12,7	518	625	550	490	79,5	81,5	105,5
	15	17,4	518	625	650	650	80,3	82,3	110,5
K09-TD	9,2	10,6	657	793	300	240	80,4	82,4	115,5
	11	12,7	657	793	390	320	80,7	82,7	116
	15	17,4	657	793	575	500	81	83	130
	18,5	21,5	657	793	650	650	81,3	83,3	157
K10-TD	11	12,7	804	970	325	275	84,6	86,6	124
	15	17,4	804	970	450	375	84,9	86,9	138
	18,5	21,5	804	970	600	525	85,2	87,2	165
K11-TD	11	12,7	903	1089	235	160	84,9	86,9	131
	15	17,4	903	1089	375	280	85,4	87,4	145
	18,5	21,5	903	1089	475	400	85,9	87,9	172
K12-TD	15	15	1007	1216	250	-	85,7	87,7	144
	18,5	21,5	1007	1216	350	275	86,2	88,2	171
	22	25,5	1007	1216	475	375	86,7	88,7	181

INSTALLATION

- For proper use, the blower should be equipped with INLET FILTER and SAFETY VALVE; other accessories available on request
- Ambient temperature from -15° to +40°C (+5° to +104° F)
- Specifications subject to change without notice
- Before installation read carefully all instructions

¹ Noise measured at 1 m distance with inlet and outlet ports piped, in accordance to ISO 3744

² Value refers to the weight of the machine with 3 Phase motor if MOR range, without motor if GOR or GVR range.

N: Installed motor power

Q: Flow rate

P: Differential pressure

Leq: Noise

PRESSURE

2900 rpm (50 Hz)

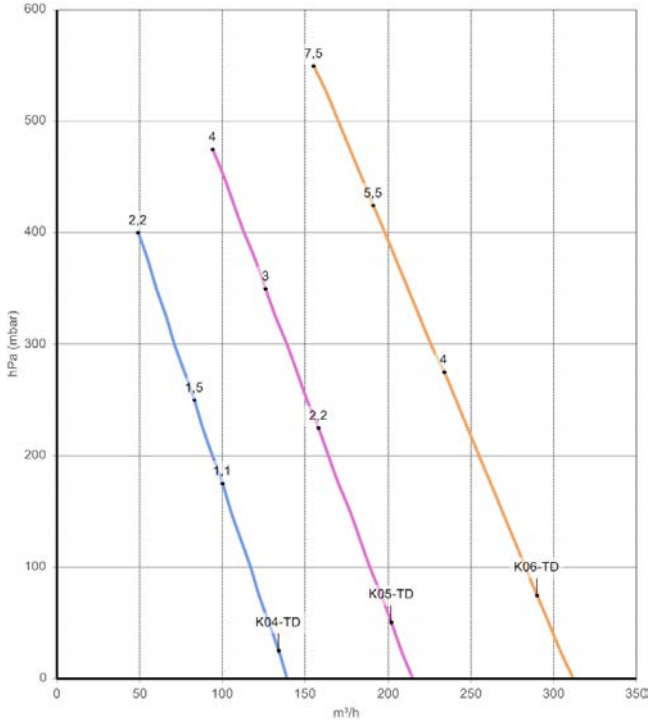

3500 rpm (60 Hz)

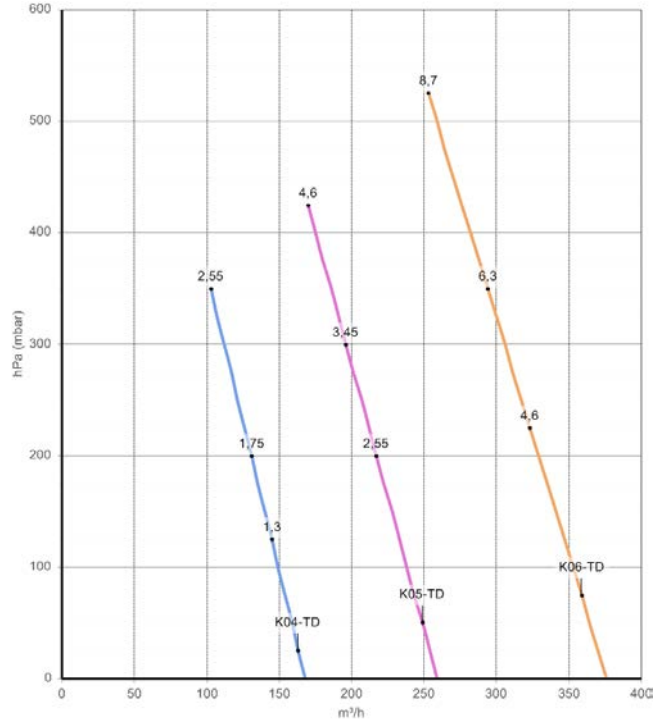

FLOW RATE

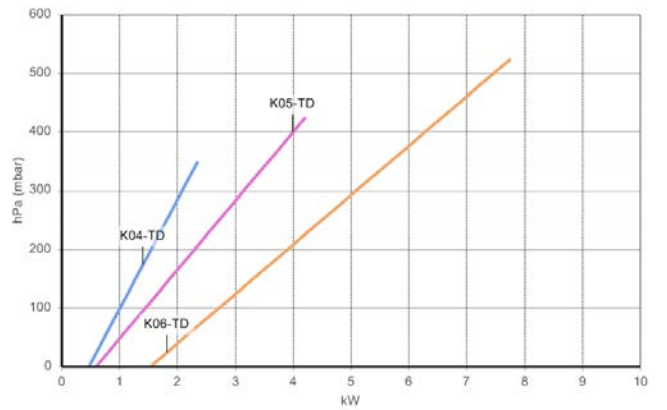
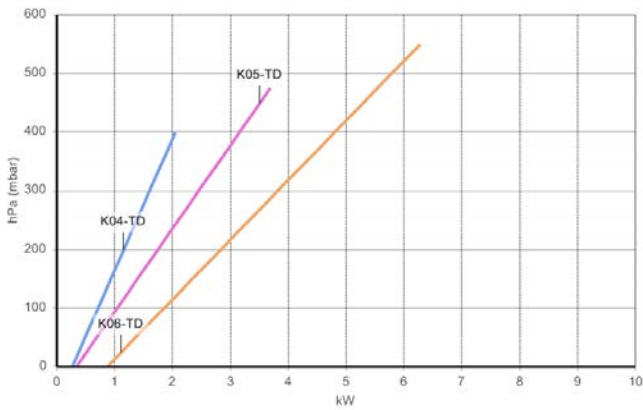

ABSORBED POWER

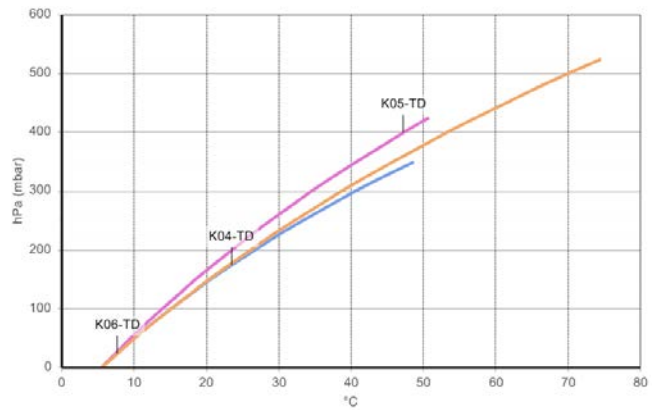
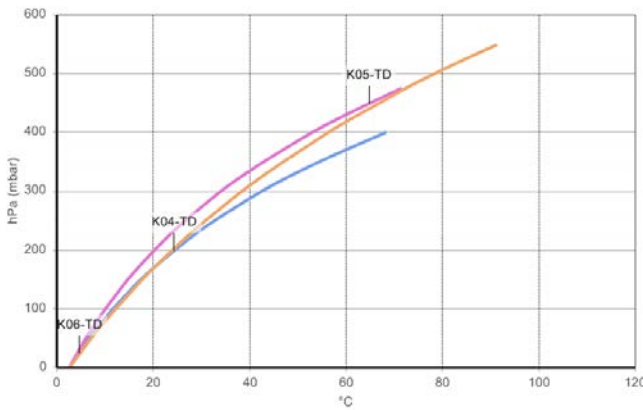

TEMPERATURE INCREASE

Curves refer to air at 20°C (68° F) temperature and 1013 mbar (29.92 In Hg) atmospheric pressure (abs) measured at inlet port.
 Values for flow, power consumption and temperature rise: ±10% tolerance
 Data can change without prior notice

PRESSURE

2900 rpm (50 Hz)

3500 rpm (60 Hz)

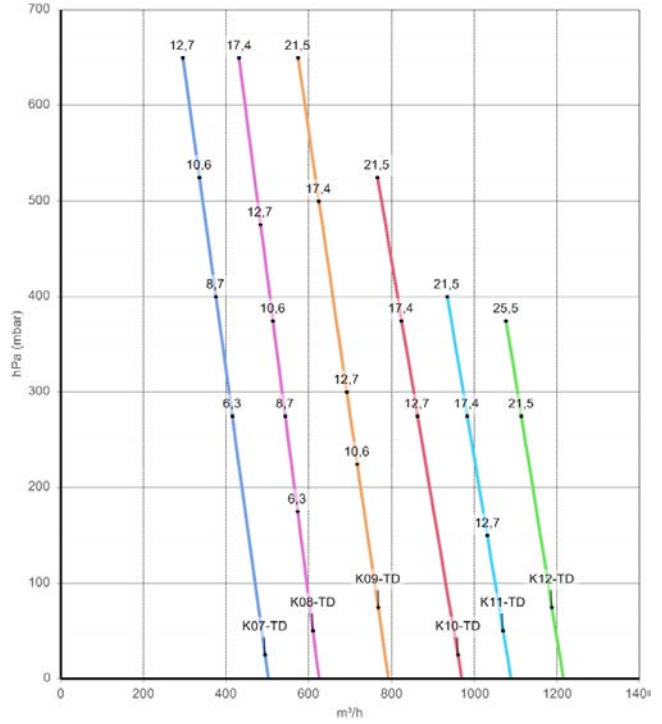
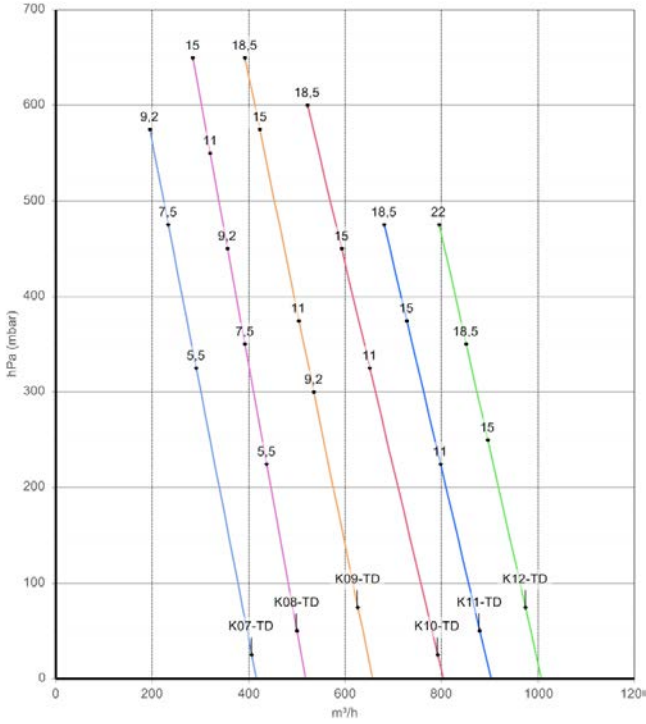

FLOW RATE

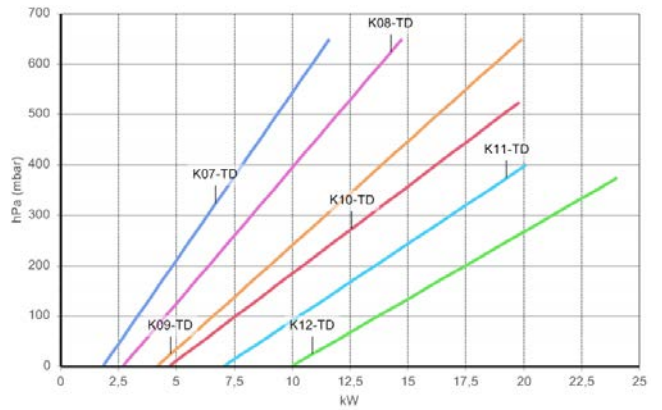
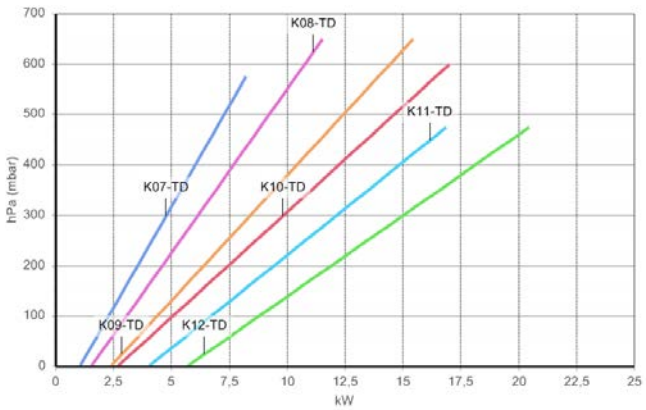

ABSORBED POWER

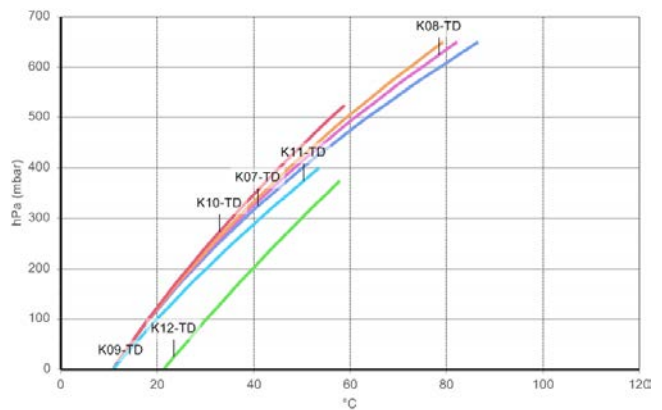
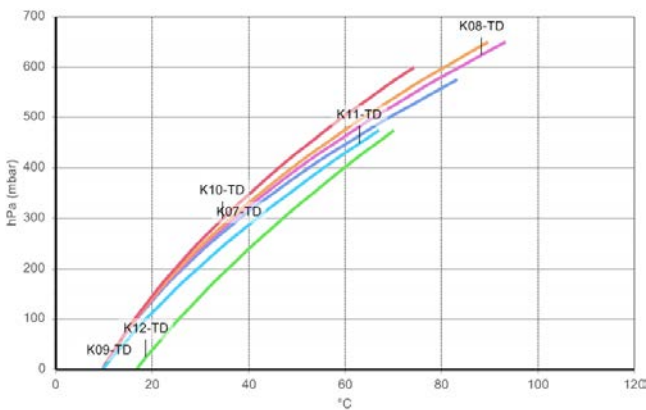

TEMPERATURE INCREASE

Curves refer to air at 20°C (68° F) temperature and 1013 mbar (29.92 In Hg) atmospheric pressure (abs) measured at inlet port.
 Values for flow, power consumption and temperature rise: ±10% tolerance
 Data can change without prior notice.

VACUUM

Model	N 2900 rpm [kW]	N 3500 rpm [kW]	Q max 2900 rpm [m ³ /h]	Q max 3500 rpm [m ³ /h]	ΔP max 2900 rpm [hPa] (mbar)	ΔP max 3500 rpm [hPa] (mbar)	Leq ¹ 2900 rpm (Lp) [dB(A)]	Leq ¹ 3500 rpm (Lp) [dB(A)]	Weight ² max [kg]
K04-TD	1,1	1,3	139	168	175	140	67,6	69,6	25,5
	1,5	1,75	139	168	250	215	68,6	70,6	26,5
	2,2	2,55	139	168	275	300	69,6	71,6	29,5
K05-TD	2,2	2,55	215	259	240	210	70,6	72,6	36
	3	3,45	215	259	350	300	72,1	74,1	40
	4	4,6	215	259	400	400	73,6	75,6	43,5
K06-TD	4	4,6	312	376	275	225	72,6	74,6	49,2
	5,5	6,3	312	376	400	350	73,6	75,6	56,5
	7,5	8,7	312	376	-	400	74,6	76,6	61,5
K07-TD	5,5	6,3	416	502	325	275	76,6	78,6	85
	7,5	8,7	416	502	425	410	76,9	78,9	90
	9,2	10,6	416	502	-	450	-	79,2	99,5
	-	12,7	416	502	-	-	-	-	100,5
K08-TD	5,5	6,3	518	625	235	180	77	79	90,5
	7,5	8,7	518	625	350	290	77,3	79,3	95,5
	9,2	10,6	518	625	450	390	77,6	79,6	105
	11	12,7	518	625	-	475	-	79,9	105,5
	15	17,4	518	625	-	-	-	-	110,5
K09-TD	9,2	10,6	657	793	300	240	79,9	81,9	115,5
	11	12,7	657	793	390	320	80,2	82,2	116
	15	17,4	657	793	450	475	80,5	82,5	130
	18,5	21,5	657	793	-	-	-	-	157
K10-TD	11	12,7	804	970	325	275	83,9	85,9	124
	15	17,4	804	970	450	375	84,2	86,2	138
	18,5	21,5	804	970	500	500	84,5	86,5	165
K11-TD	11	12,7	903	1089	235	160	84,2	86,2	131
	15	17,4	903	1089	375	280	84,7	86,7	145
	18,5	21,5	903	1089	450	400	85,2	87,2	172
K12-TD	15	17,4	1007	1216	250	-	85	-	144
	18,5	21,5	1007	1216	350	275	85,5	87,5	171
	22	25,5	1007	1216	425	375	86	88	181

¹ Noise measured at 1 m distance with inlet and outlet ports piped, in accordance to ISO 3744.

² Value refers to the weight of the machine with 3 Phase motor if MOR range, without motor if GOR or GVR range.

N: Installed power

Q: Flow rate

P: Differential pressure

Leq: Noise

VACUUM

2900 rpm (50 Hz)

3500 rpm (60 Hz)

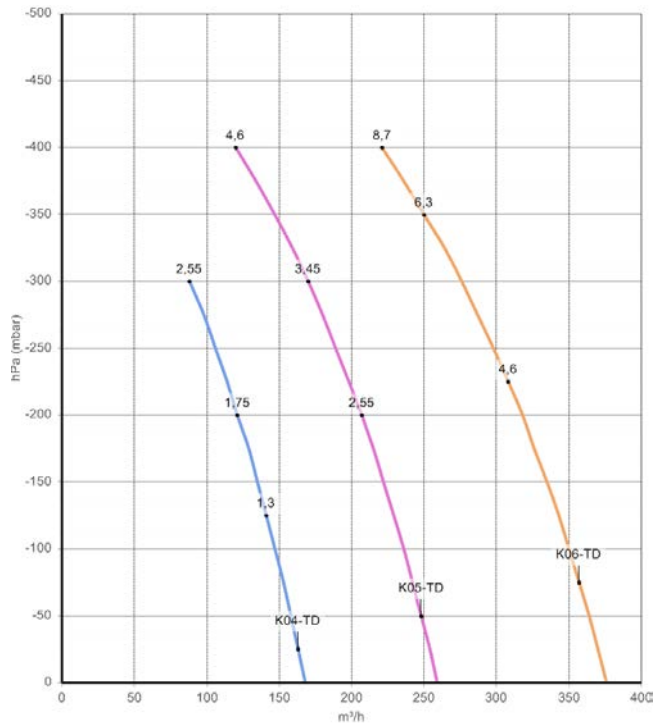
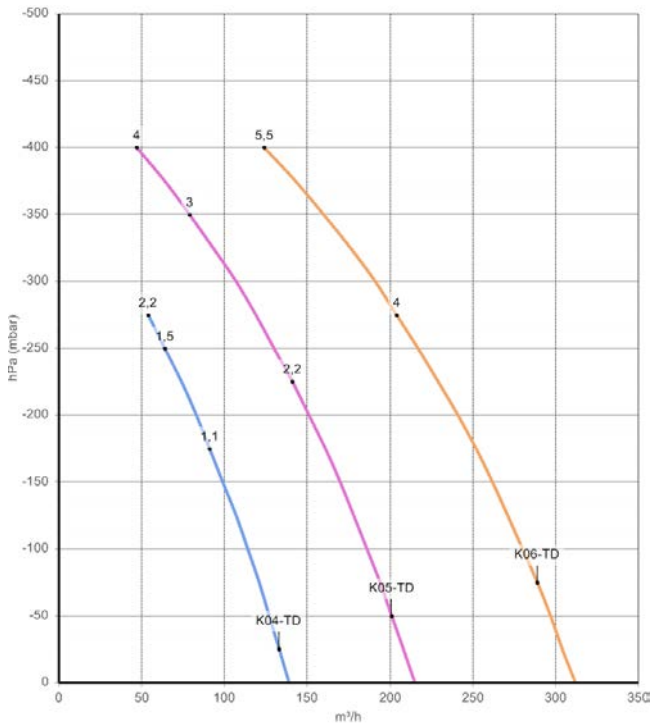

FLOW RATE

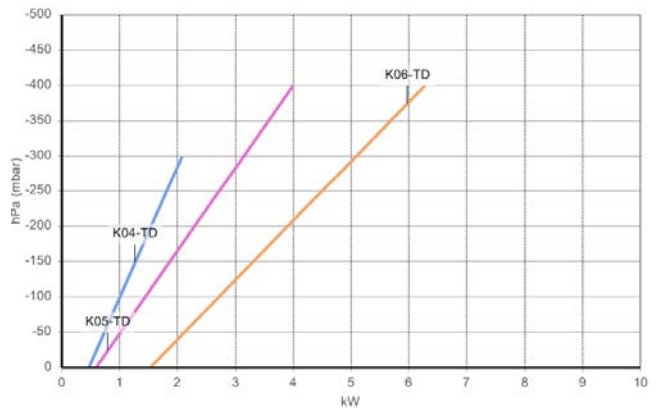
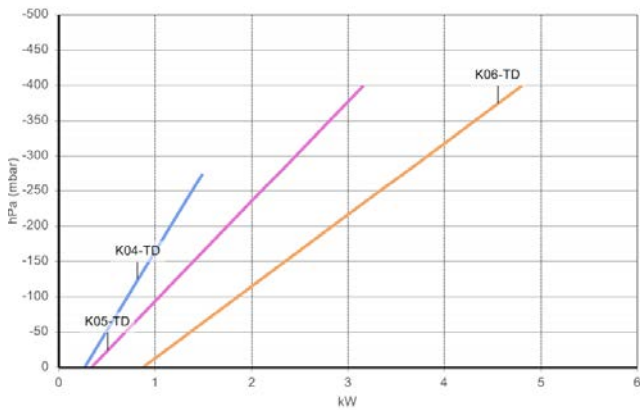

ABSORBED POWER

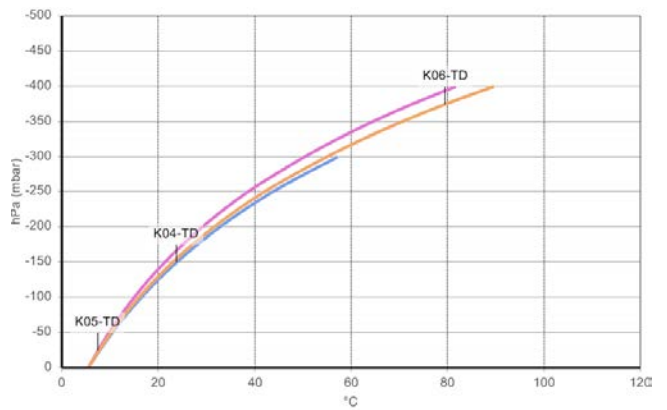
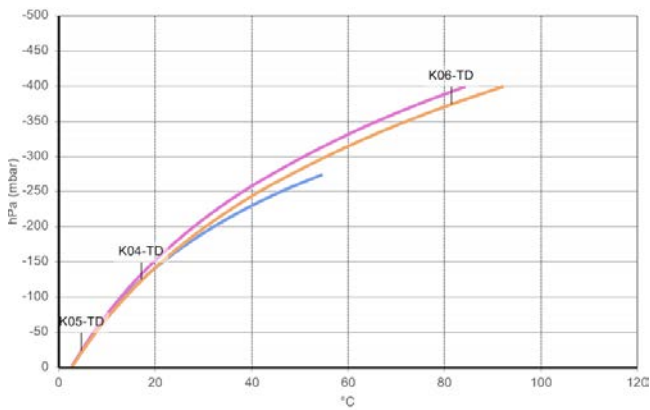

TEMPERATURE INCREASE

Curves refer to air at 20°C (68° F) temperature, measured at inlet port and 1013 mbar (29.92 In Hg) atmospheric backpressure (abs).
 Values for flow, power consumption and temperature rise: ± 10% tolerance
 Data can change without prior notice.

VACUUM

2900 rpm (50 Hz)

3500 rpm (60 Hz)

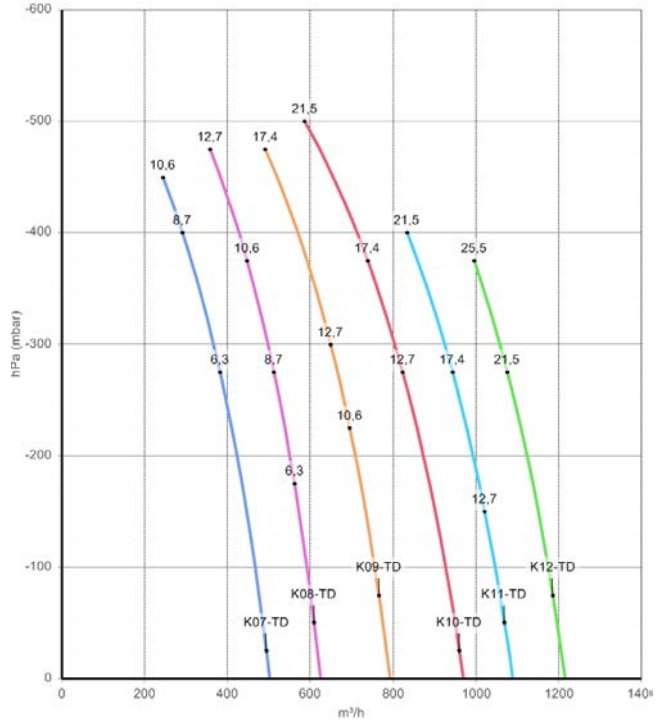
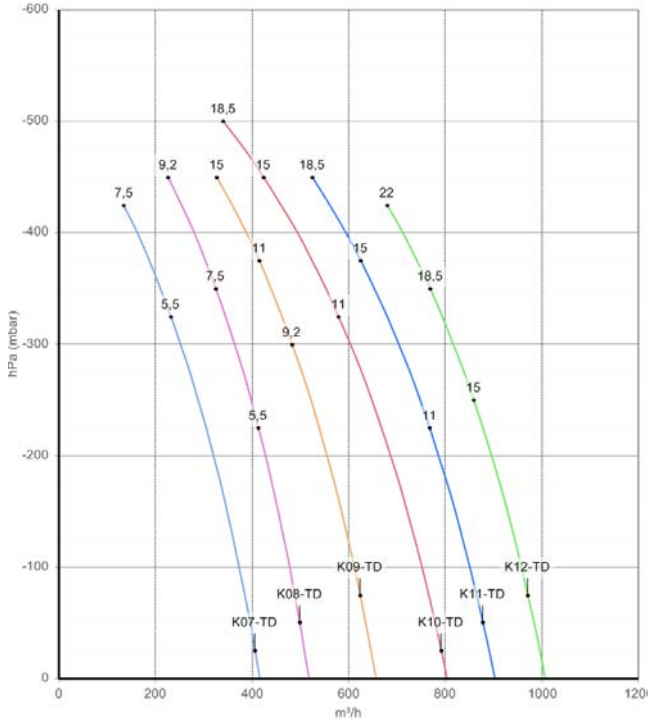

FLOW RATE

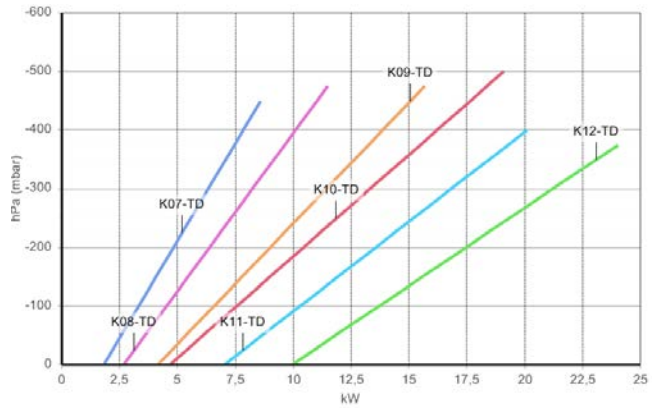
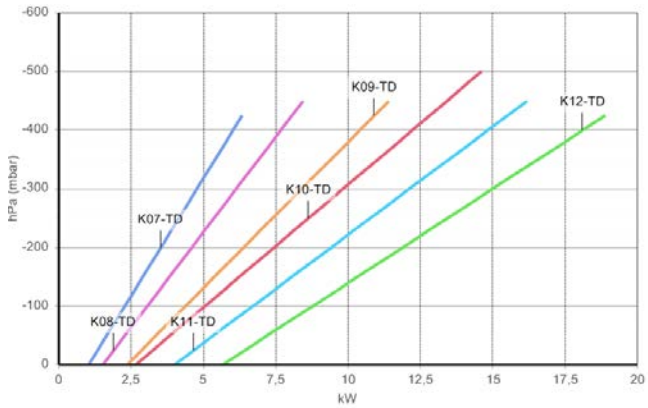

ABSORBED POWER

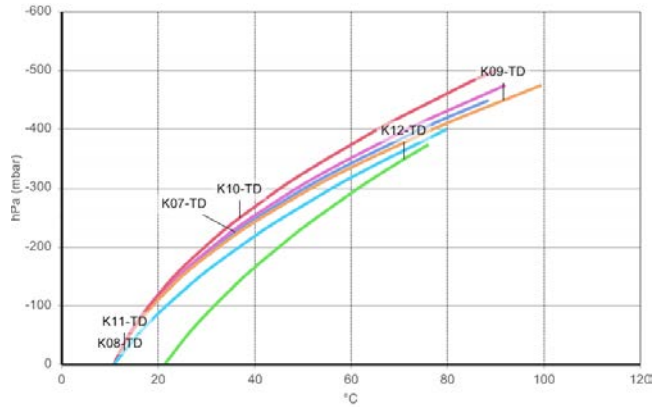
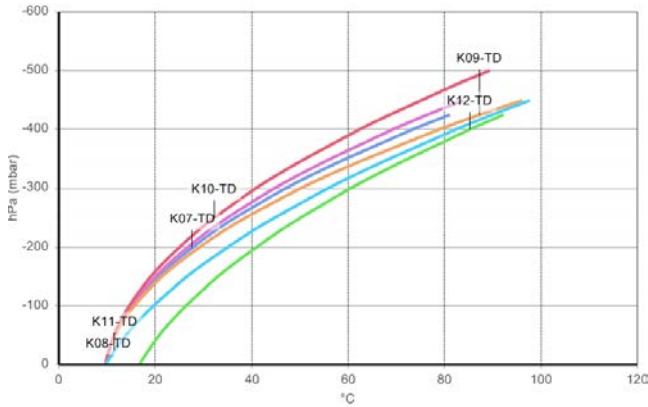

TEMPERATURE INCREASE

Curves refer to air at 20°C (68° F) temperature, measured at inlet port and 1013 mbar (29.92 In Hg) atmospheric backpressure (abs).
 Values for flow, power consumption and temperature rise: ± 10% tolerance
 Data can change without prior notice.

DIMENSIONS (K04-TD/K05-TD/K06-TD)

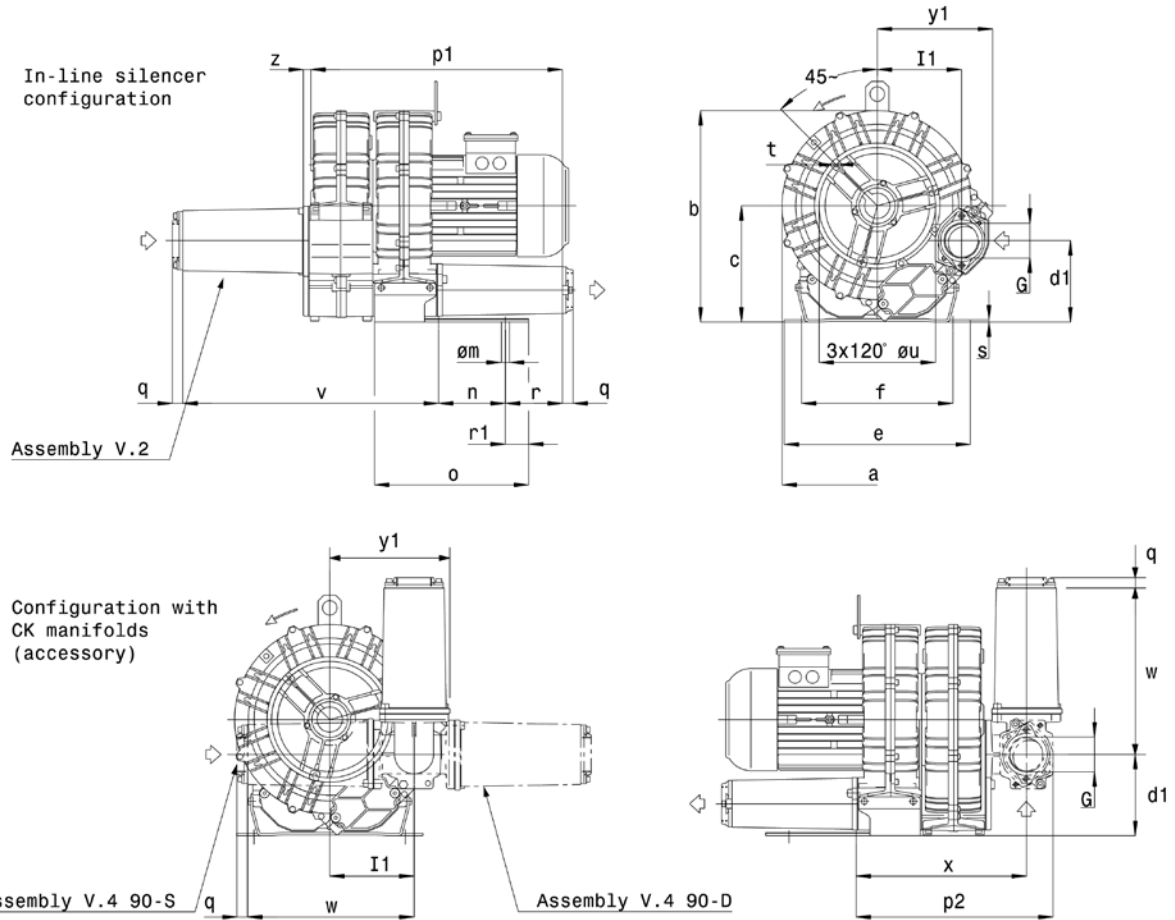

Dimensions in mm - FOR REFERENCE ONLY

Model	a	b	c	d	d1	e	f	G	H
K04-TD	285	315	172	49	121	255	225	G 1" ½	375
K05-TD	327	365	200	54	140	320	260	G 2"	485
K06-TD	376	420	232	59	170	325	290	G 2"	580

Model	i1	i2	m	n	o	p1	p2	q	r
K04-TD	123	51	12	95	171	316	254	18	70
K05-TD	145	60	15	115	265	428	340	18	98
K06-TD	151	73	15	140	265	506	354	18	136

Model	r1	s	t	u	v	w	x	y	y1	z
K04-TD	15	4	M6	175	288	188	214	173	166	18
K05-TD	40	4	M8	200	440	286	293	206	200	19
K06-TD	19	4	M8	240	455	286	308	210	205	19

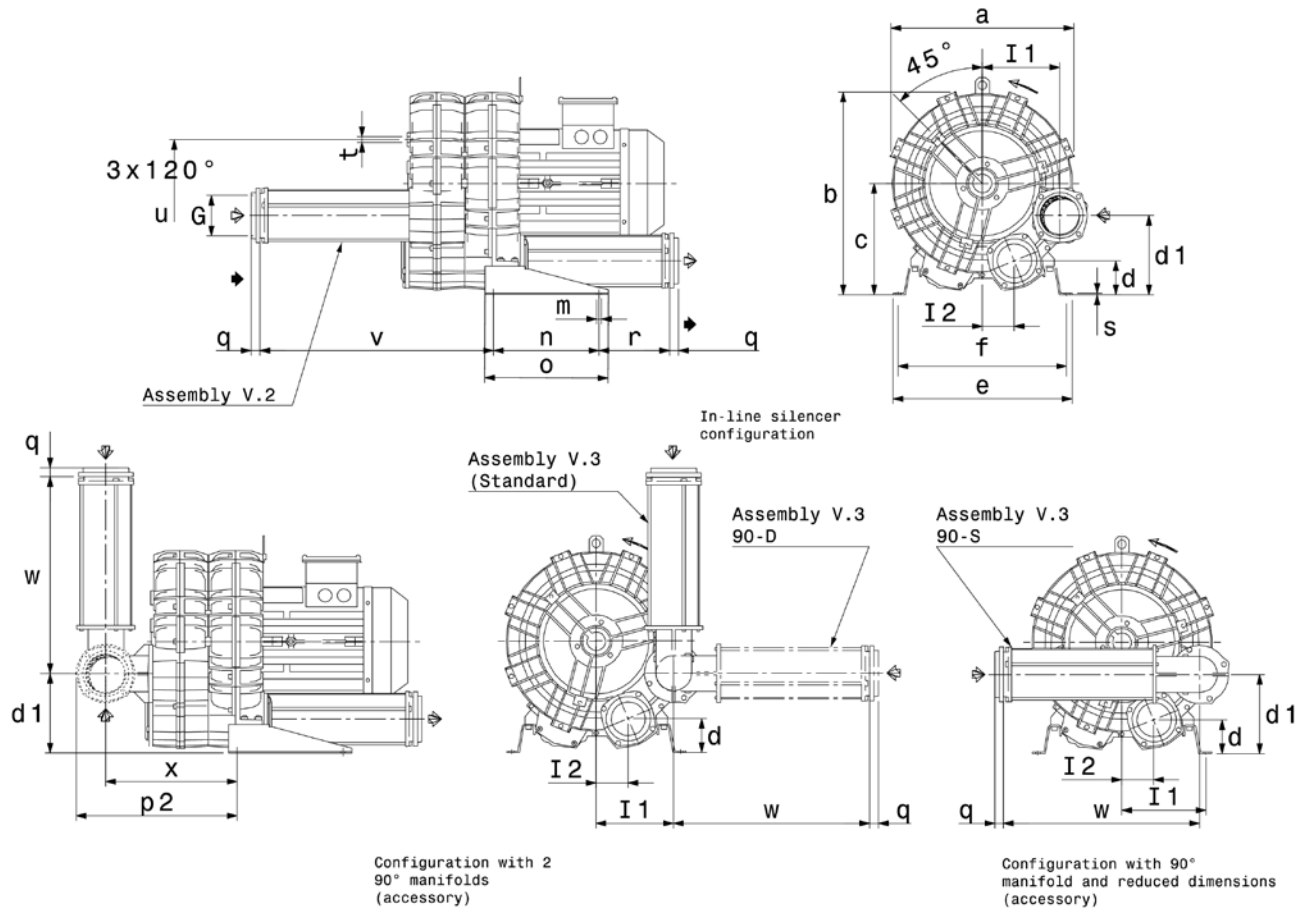
DIMENSIONS (K07-TD/K08-TD/K09-TD/K10-TD/K11-TD/K12-TD)

Dimensions in mm - FOR REFERENCE ONLY

Model	a	b	c	d	d1	e	f	G	H
K07-TD	424	481	269	82	192	468	438	G 3"	620
K08-TD	457	498	269	82	192	478	448	G 3"	620
K09-TD	492	561	315	96	225	508	478	G 4"	650
K10-TD	516	573	315	96	225	508	478	G 4"	745
K11-TD	542	602	332	90	232	538	508	G 4"	760
K12-TD	548	605	332	90	232	538	508	G 4"	803

Model	i1	i2	m	n	p1	p2	q	r	o
K07-TD	187	77.5	13	300	649	392	25	137	350
K08-TD	187	77.5	13	300	649	392	25	137	350
K09-TD	220	91	13	300	745	455	25	199	350
K10-TD	220	91	13	300	745	455	25	199	350
K11-TD	242	100	13	300	765	470	25	204	350
K12-TD	242	100	13	300	768	470	25	204	350

Model	s	t	u	v	w	x	y	z
K07-TD	5	M8	295	581	481	319	260	16
K08-TD	5	M8	310	581	481	319	260	16
K09-TD	5	M8	360	663	556	372	302	16
K10-TD	5	M8	360	663	556	372	302	16
K11-TD	5	M8	390	678	556	387	324	16
K12-TD	5	M8	390	678	556	387	324	16

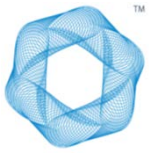

FPZ
BLOWER TECHNOLOGY

FPZ, Inc

Soukville, Wisconsin
USA
usa@fpz.com

FPZ Espana & Portugal

Barcelona
Espana
mila.lozano@fpz.com

FPZ France S.a.r.l.

St. Priest
France
france@fpz.com

HEADQUARTERS

FPZ S.p.A.

Concorezzo (MB)
Italy
info@fpz.com

FPZ México/LA

Zapopan, Jalisco
México
mexico@fpz.com

FPZ UK

Andover, Hampshire
United Kingdom
uk@fpz.com

FPZ Austria & Germany

Krems
Austria
vertrieb@fpz.com